



International Journal of Applied Science and Technology

ISSN 2221-0997 (Print), 2221-1004
(Online)

Editorial Board

Chief Editor

Dr. Nan Hu

University of Utah

United States

Editors

Chris Koch, Ph.D., Professor of Psychology, George Fox University, USA.

M. Chandra Sekar, R.Ph., Ph.D, Associate Professor, College of Pharmacy, University of Findlay, 1000 N. Main Street, Findlay, OH 43015, USA.

Dr. Rajesh Tiwari, Department of Chemistry, Louisiana State University, Baton Rouge, LA 70803, USA.

Tarab Ahmad, Ph.D, Assistant Professor, Department of Chemistry, Western Illinois University, 324 Currens Hall, Macomb, IL 61455, USA.

Linda Gao, Assistant Professor, Ph.D., Department of Chemistry, Box 8013, University of Mary Hardin-Baylor, Belton, Texas, United States.

Md. Mamin Ullah, Director of Centre for Promoting Ideas (CPI), Bangladesh. Executive Editor, International Journal of Applied Science and Technology.

Jared Sagini Keengwe, PhD, Associate Professor, University of North Dakota, Department of Teaching & Learning, 231 Centennial Drive STOP 7189, Grand Forks, ND 58202-7189, USA.

Voltaire Mistades, Physics Department, De La Salle University, Manila, Philippines.

Sreejith Aravindakshan, SUTROFOR Erasmus Mundus Fellow , Institute of International Forestry and Forest Products, Dresden University of Technology (TUD), PF 1117, 01735 Tharandt, Dresden, Germany.

Prof. Dr. Mirza Barjees Baig, Department of Agricultural Extension and Rural Society ,College of Food and Agricultural Sciences, King Saud University , P.O. Box 2460, Riyadh 11451, Kingdom of Saudi Arabia.

Dr. Mohammad Reza Iravani, Associate Professor, Department of Social work, Azad University of Khomeinishahr, Islamic Azad University, Khomeinishahr branch, Khomeinishahr, Esfahan, Iran.

Dr. S. Madhavi, Professor, Computer Science and Engineering, PVP Siddhartha UInstitute of Technology, India.

Dr. Justin Sentian, Senior Lecturer, Head of Environmental Science Programme, School of Science and Technology, Universiti Malaysia Sabah, Sabah, Malaysia.

Dr. Jason L. Powell, Director of Sustainable Communities Knowledge Exchange, Academic Lead for Internationalisation, Knowledge Exchange and Employability, The School of Education and Social Science, The University of Central Lancashire, UNITED KINGDOM.

Dr. T. Meyyappan, Ph.D., Associate Professor, Department of Computer Science and Engineering, Alagappa University, Karaikudi - 630 003, Tamilnadu, South India.

Dr. Md. Mizanur Rahman, Post Doctoral Fellow, Material Science and Engineering Cluster, Faculty of Engineering, University of Malaya, Malaysia.

Dr . Mohammad Alaya, Assistant Professor in Econometrics, Alhoussain Bin Talal University, Jordan.

H. Ridvan Yurtseven, Professor, Canakkale Onsekiz Mart University, Gokceada school of Applied Sciences, Head of Gastronomy Department, Gokceada/Canakkale/Turkey.

Estelle Davutoglu, Departmental Coordinator, Department of International Entrepreneurship, Faculty of Economics and Administrative Sciences, TOBB University of Economics and Technology, Turkey.

H. Ridvan Yurtseven, PhD, Professor, Head of Gastronomy Department, Canakkale Onsekiz Mart University, Canakkale-Turkey.

Assoc. Prof. Dr. Seikh Farid Uddin Akter, PhD, Dept. of Community Medicine, Kulliyyah (Faculty) of Medicine, International Islamic University Malaysia (IIUM), Jalan Sultan Ahmad Shah, Bandar Indera Mahkota, 25200 Kuantan, Pahang Darul Makmur, Malaysia.

Brian L. Heuett, Associate Professor of Communications, Department of Communication, Southern Utah University, Cedar City, UT 84720, USA. Phone: Dept. (435)586-7861

Prof. P. Malyadri, PhD, Principal, Government Degree College, Osmania University, Tandur-501141 | Ranga Reddy District, Andhra Pradesh, India.

Dr. Jur. Tunay Köksal, Assistant Professor of International Trade & Logistics Law, Ankara University, Ankara - Turkey.

Ali Asghar Ghadimi, Ph.D., Assistant Professor, Head of Electrical Engineering Department, Faculty of Engineering, Arak University, Sardasht Square, Arak University Campus, Arak, 38165-875, Iran.

Dr. Sukumar Senthilkumar, Post Doctoral Research Fellow, (Mathematics and Computer Science & Applications), Universiti Sains Malaysia, School of Mathematical Sciences, Pulau Pinang-11800, Malaysia.

Professor Dr. Kamaruzaman Jusoff, Faculty of Forestry, University Putra Malaysia, Seradng 43400 Selangor, Malaysia.

Belgin Yildirim, PhD RN, Assistant Professor, Aydın School of Health, Adnan Menderes University, Aydın, Turkey.

Şükran Özkahraman, PhD RN, Assistant Professor, Faculty of Health Science, Süleyman, Demirel University, Isparta, Turkey.

Joel Hicks, MSRS, RT(R), Assistant Professor, Radiologic Sciences, Northwestern State University, 1800 Line Avenue, Shreveport, LA 71101, USA.

Ass. Prof. Dr. Birgit Oberer, Information Technology Department, Kadir Has University, Turkey.



Copyright @ 2014: www.ijastnet.com | All Rights Reserved.

Genamics JournalSeek

International Journal of Applied Science and Technology *Int J Appl Sci Tech*

Published/Hosted by [Centre for Promoting Ideas](#). ISSN (printed): 2221-0997. ISSN (electronic): 2221-1004.

International Journal of Applied Science and Technology (IJAST) is an open access, peer reviewed and refereed international journal published by Center for Promoting Ideas (CPI), USA. The main objective of IJAST is to provide an intellectual platform for the international scholars. IJAST aims to promote interdisciplinary studies in science and technology and become the leading journal in science and technology. The journal publishes research papers in the fields of science and technology such as Astronomy and astrophysics, Chemistry, Earth and atmospheric sciences, Physics, Biology in general, Agriculture, Biophysics and biochemistry, Botany, Environmental Science, Forestry, Genetics, Horticulture, Husbandry, Neuroscience, Zoology, Computer science, Engineering, Robotics and Automation, Materials science, Mathematics, Mechanics, Statistics, Health Care & Public Health, Nutrition and Food Science, Pharmaceutical Sciences, and so on.

Further information

- [International Journal of Applied Science and Technology website](#)

Category Link

- [Biological Sciences - Miscellaneous](#)

Study and Characterization of a Mineral Belayed Material: Case Tiles Coated Granites

Toukourou Chakirou Akanho

Fagla Fanou Zinsou Benoît

Prodjinonto Vicent

Laboratoire d'Energétique et de Mécanique Appliquée (LEMA)

Ecole Polytechnique d'Abomey Calavi Université

Université d'Abomey Calavi (UAC) 01 BP 2009 COTONOU BENIN

Bello Sobour

Pôle Technologique de Promotion des Matériaux Locaux (POTEMAT)

Ecole Polytechnique d'Abomey-Calavi (EPAC)

Université d'Abomey Calavi (UAC)

01BP : 2009 COTONOU BENIN

Abstract

The study of water absorption and mechanical strength of the belayed coupled with normative provisions that enable the selection of tiles coated granites are suitable for both internal and external coatings on our premises and 20% rate coarse sand, the bi layers have good three-point flexural strength and compression; and a normal water absorption rate .They therefore can in these circumstances be used for coating. Standardized tests on sand and evaluation of mechanical characteristics of specimens (three-point bending strength and compression strength) by the three-point bending tests and compression are between the other methods. Indeed, the sample with coarse sand rate of 20% has a three-point flexural strength equal to 9,875MPa. The test results by 3 points bending method was used to assess the rate at 5.27% of uncertainty and stress fractures samples, As for compression, compressive strength of the specimens at first decreases with the assay (20% to 40%) in coarse sand. Then, they oscillate as coarse sand rate increases finally, the water absorption stimulates it decreases gradually as the coarse sand rate decreases with the exception of the 5050 sample.

Keywords: two-layer, water absorption, mechanical resistance.

1. Introduction

Cement bilayers / Granitos are inexpensive materials and environmentally friendly, that can be produced using relatively simple technology. They are mainly used in building non-structural applications, as indoor and outdoor coverings, light partitions, tiles, tiles, pavers, screeds, noise barriers and fire .(Moslemi, 1999). They possess interesting properties including light weight, waterproofing, adhesion, mechanical and thermal performance, fire resistance, impact resistance. Many products already on the market, but the knowledge in this field are still limited and studies are needed to better understand certain mechanisms and improve the properties of these materials. Several problems related to the high alkalinity of the cementations medium, and use of the belayed materials have been identified including:

- The hydration process, during the setting of the cement is sometimes inhibited by the release of some extractable molecules, or other substances from the alkaline degradation of the belayed;
- The mechanical properties of cements bilayers / granitos are often impaired in the long term, due to the alkaline degradation of cement;
- The hygroscopic nature of the cement is often responsible for dimensional variations in the bilayer which not only affect the properties at the interface of the bilayer cement / terrazzo, but also limit the scope thereof;
- Ageing under the action of water and the temperature of the bilayer;
- Sometimes prohibitive cost (time and cost study and implementation).

In this context, we asked ourselves the question: the two-layer material consisting of cement mortar (sand cement) and a mineral coating (terrazzo) offers good strength? The answer to this question, in our humble opinion, can only be achieved by a Study and Characterization of a two-layer material consisting of cement mortar (sand cement) and a mineral coating (terrazzo). Thus, we decided to choose as the theme of memory "Design and Characterization of a mineral layer material: Case terrazzo tiles coated".

2 Materials and Methods

2.1 Materials

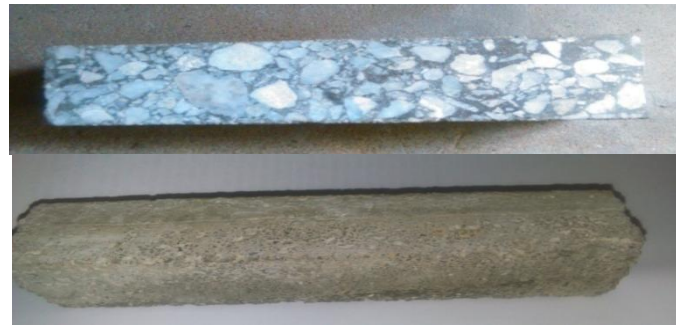

Figure 1 : Sample bilayer : Tiles coated granites

1. Samples and way of confection [BAGAN G. C 2002].

Samples	Coarses and proportion in%	Mediums and Proportion in%	Totals and mass MS in grams (g)	Cement weight MC = 1/3 MS in grams (g)	Water mass ME = 0,5 MC en grams (g)
2080	20	80	1450	483,33	241,67
3070	30	70	704	234,67	117 ,33
4060	40	60	864	288	144
5050	50	50	1024	341,33	170,67
6040	60	40	898	299,33	149,67
7030	70	30	1217	405 ,67	202,83
8020	80	20	815	271,67	135 ,83

Table 1: Summary dosages

- Testing Machines

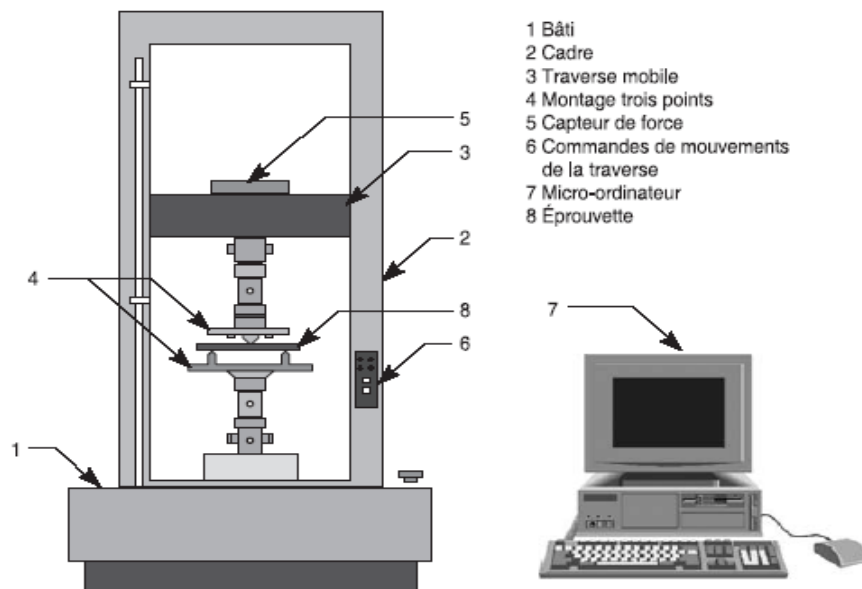

Figure 2: Test apparatus for bending three points on the specimen

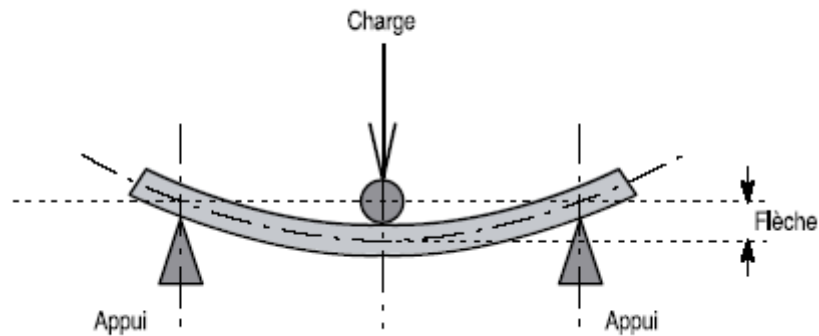

Figure 3: bending test devices three points on the specimen

-Various facilities

The materials used are among others the sand, cement; water and crushed marble. We will look at the influence of the grain size of the sand on the mechanical properties of the bilayer. These properties are very numerous, but this study is limited to the study:

- The water absorption;
- 3-point flexural strength;
- Compressive strength

Prior to the completion of the bilayer substrate component, we have made initially testing the sand in order to characterize it. These tests are performed at the testing laboratory and research in Civil Engineering (LERGC). This characterization was to determine the following properties:

- The particle size
- The equivalent of sand
- The actual pre-dried density (specific gravity)
- The bulk density (bulk density)
- The water content

After characterization sand, specimen preparation occurs while performing the mortar and varying granular compositions to release the proper dosage.

Samples	2080	3070	4060	5050	6040	7030	8020
Proportion of coarse sand%	20	30	40	50	60	70	80

After this step, we asked what the coating terrazzo .a both obtained bilayer, we weighed with a precision balance and we immersed in water for 28 days. The 28days achieved, we have made the three points bending tests and compression 28days on said test piece and the water absorption rate.

2.2 Methods

2.2.1 Water absorption rate

The procedure is to completely immerse the samples in water for 24 hours at room temperature and then in their weightings after being wiped .If there is respectively denoted by m1 and m2 the initial mass of the test piece and the water-saturated in grams, the open porosity, denoted P is determined by the expression [BRAZIER JF, 1991].

2.2.2 Bending test three points

The press used for our experiments is a hydraulic press with digital display. We focus the specimen and perpendicular to its length. We submit to all a constant load and note the load at break.

2.1.3 Compression Test

The procedure adopted is the compression over two half specimens from the three-point bending test. The two halves are not always regular in shape.

- Open porosity, denoted P is determined by the expression [BRAZIER JF, 1991].

$$P (\%) = \frac{m2-m1}{m1} \times 100 \tag{1}$$

- The flexural strength of the test pieces was determined by the relation [Bailon JP. Et al, 2000]:

$$R_f = \frac{1,5 \times F_f \times l}{b^3} \quad \text{with} \quad (2)$$

l: distance between supports (mm)

Rf: flexural strength in Newton’s per (mm²)

b: side of the prism square section (mm)

Ff: load applied to the middle of the prism at break (N)

- The standard deviation is determined from the following formula:

$$E = \sqrt{\frac{1}{n} \sum (\bar{x} - x_i)^2} \quad \text{With} \quad (3)$$

N: number of test pieces

X: the average flexural strengths (MPa)

Xi: the bending strength of each test piece (MPa)

- The uncertainty is determined from the following formula:

$$I (\%) = \frac{E}{\text{moyenne}} \times 100 \quad (4)$$

- The compressive strength is determined by the formula

$$R_c = \frac{F_c}{1600} \quad \text{with} \quad (5)$$

Rc: compressive strength in Newtons per square millimeter

Fc: Maximum breaking load, in newtons

3. Results And Discussion

Samples	2080	3070	4060	5050	6040	7030	8020
Coarse sand rate%	20	30	40	50	60	70	80
Rate% fine sand	80	70	60	50	40	30	20
Flexural strength (MPa)	9,875	9,75	7	8,500	7,125	9,125	8,625
Standard deviation (MPa)	9,875±0,18	9,75±0,37	7±0,64	8,500±0,64	7,125±0	9,125±0,77	8,625±0,53
Uncertainty (%)	1,82	3,79	9,14	7,53	0	8,44	6,14
Average uncertainty (%)	5,27						

Table 2: Flexural test results Summary of 3 points to 28

Samples	2080	3070	4060	5050	6040	7030	8020
Coarse sand rate%	20	30	40	50	60	70	80
Rate% fine sand	80	70	60	50	40	30	20
Flexural compression (MPa)	22,083	21,94	18,437	19,124	18,458	21,572	20,687
Standard deviation (MPa)	22,083±1,91	21,94±2,17	18,437±0,26	19,124±1,44	18,458±0,10	21,572±0,51	20,687±0,64
Uncertainty (%)	8,65	9,89	1,41	7,53	0,54	2,36	3,09
Average uncertainty (%)	4,78						

Table 3: Summary of compression test results at 28 days

Samples	4060	6040	5050	8020	7030	3070	2080
f_c^{28} (MPa)	18,437	18,458	19,124	20,687	21,572	21,94	22,083
f_t^{28} (MPa)	7	7,125	8,500	8,625	9,125	9,75	9,875
$\frac{f_t^{28}}{f_c(4060)}$	1	1,02	1,21	1,23	1,30	1,39	1,41

Table 4: Increase in flexural strength as a function of the compressive strength of test specimens

3.1 Strength of test specimens

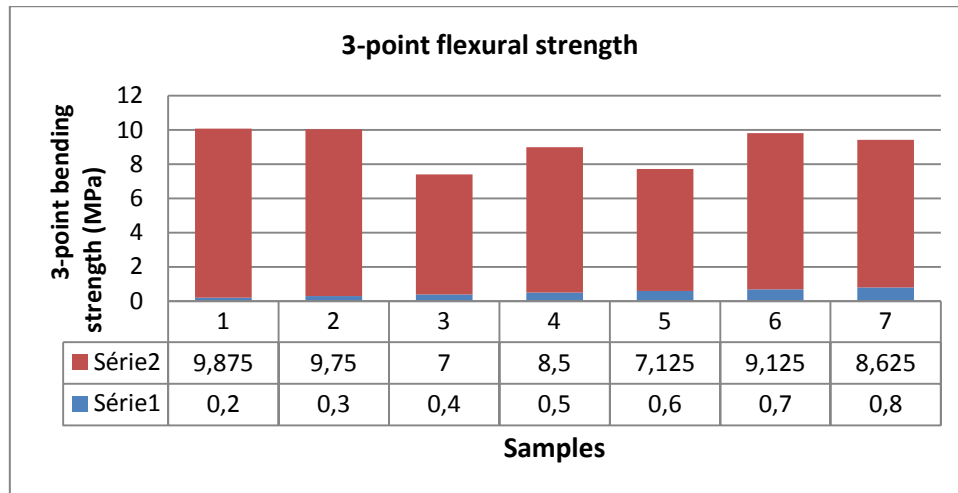

Figure 4: Bending strength 3 points specimens

Analysis and discussion: The flexural strength 3 points specimens decrease initially with the assay (20% to 40%) in coarse sand. Then, they oscillate as coarse sand rate increases. The sample with coarse sand rate of 20% has a three-point flexural strength equal to 9,875MPa. Thus; the variation of these resistors allows us to say that the more resistant the sample is 2080 sample. Analysis and discussion: When the force reaches a maximum value, one or more cracks appear and spread more quickly than the loading speed is high. This means that the inclusions of the matrix affects the flexural strength of these materials such as a sample behavior is similar to that of brittle materials [Bailon JP. Et al, 2000]. The test results by 3 points bending method was used to assess the rate at 5.27% of uncertainty and stress fractures samples, the gap of uncertainty is low, it can be concluded that the more resistant the sample is 2080.

3.1 Strength of test specimens

Similarly, graphs of the curve of figure 5 outline the compressive strength at 28 days of test specimens.

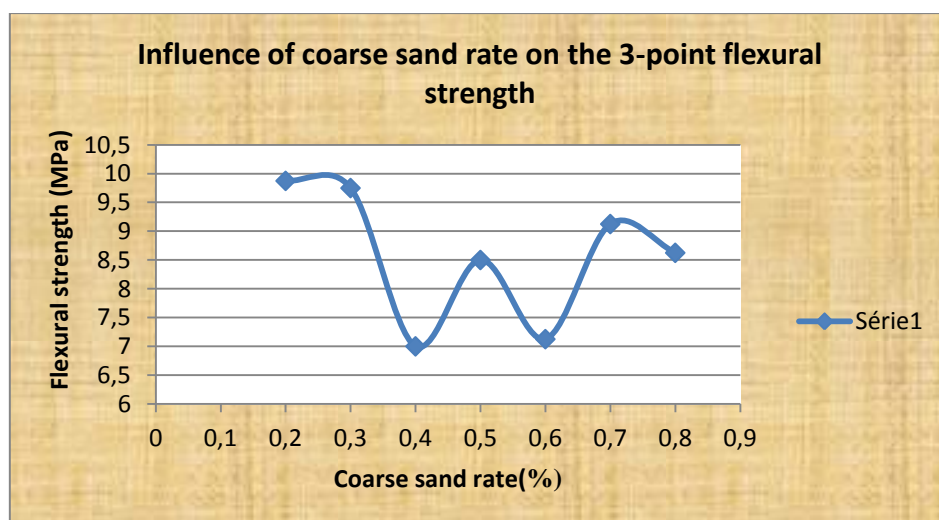

Figure 5: Compressive strength at 28 days of test specimens

Analysis and Discussion: Similarly, compressive strength of the specimens decreases initially with the assay (20% to 40%) in coarse sand.

Then, they oscillate as as coarse sand rate increases.

3.2 Influence of coarse sand rate on the compressive strength at 28 days

The curve of figure 6 tells us about the influence of coarse sand on the three-point flexural strength of test specimens.

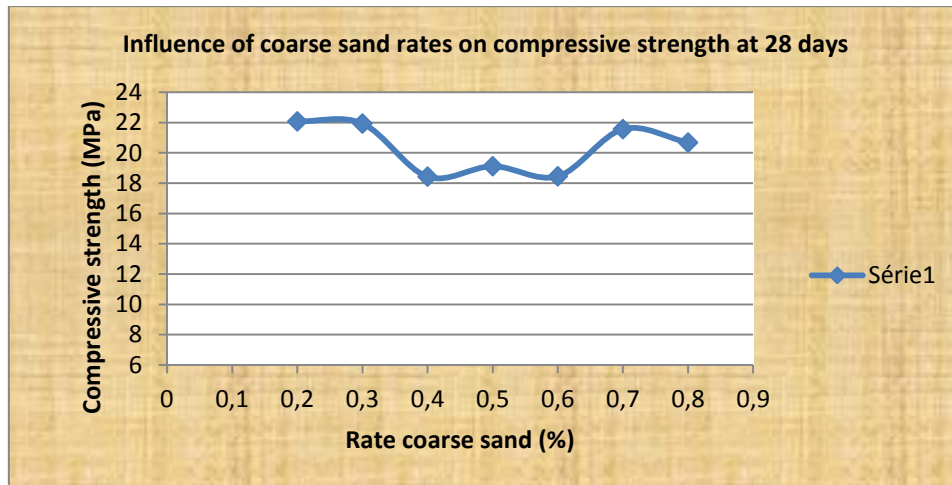

Figure 6: Influence of coarse sand rate on the compressive strength at 28 days

Analysis and discussion: At the start of the test, we note that there is increase in strength as it occurs no deformation. This can be explained by the existence of certain cohesion between the elements of the material .Then there is a relapse of force before it increases again. This is due to the interface which is located between the substrate and the coating. Similarly, when the force reaches a maximum value, one or more cracks appear and spread more quickly than the loading speed is high. This means that the inclusions in the matrix influence the compressive strength of these materials such behavior .The curve of the figure 7 Increase in flexural Strength as a function of compressive strength of test specimens.

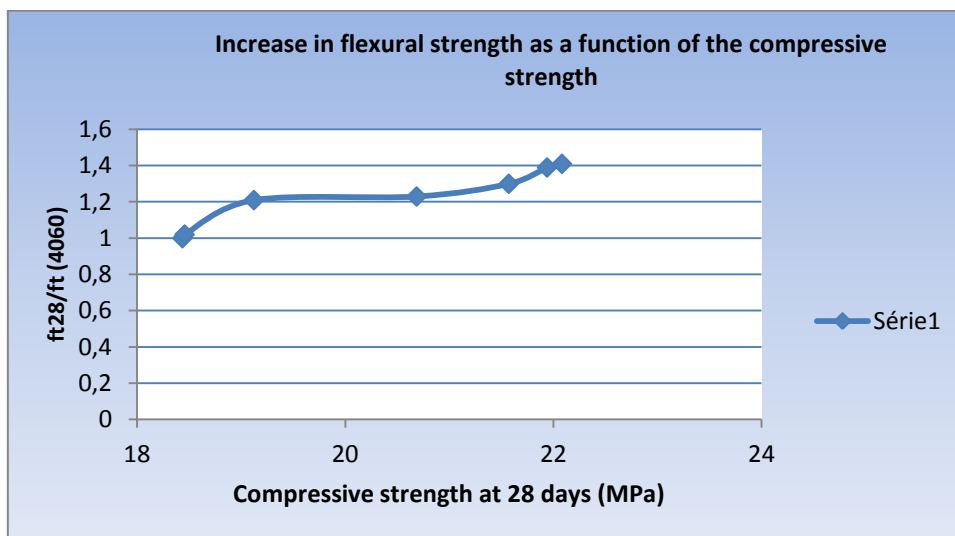

Figure 7: Increase in flexural strength as a function of the compressive strength of test specimens

Analysis and Discussion: The increase in the flexural strength according to the compressive strength is shown in the curve of figure 7. It is noted that this increase follows a logarithmic function where the rate of increase decreases the compressive strength increases. Such behavior of the samples is similar to the mechanical behavior of concrete and hydro mechanical

3.3 Water absorption rate The graphs of the figure 8 outline the samples of water absorption rate

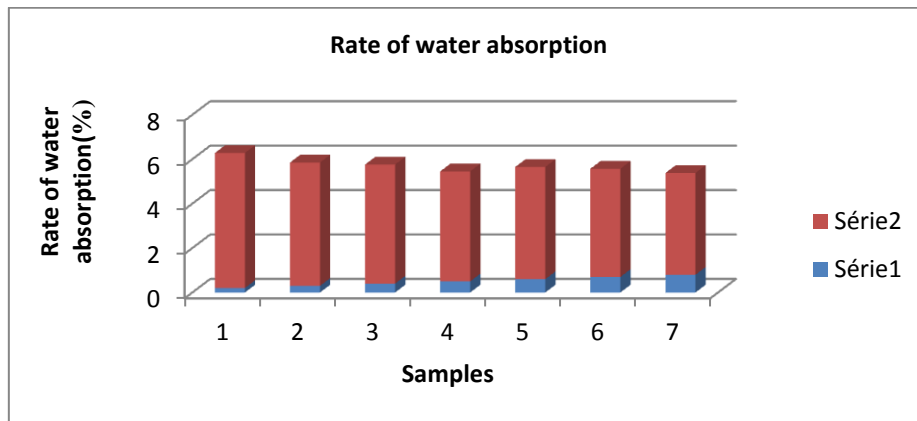

Figure 8: water absorption rate of the samples

Analysis and discussion: Through the graph, we see that the water absorption rate decreases gradually as the coarse sand rates decline with the exception of the sample 5050. This exception is explained by the equal distribution of fine sand and coarse levels.

∞ Influence of coarse sand on the rate of water absorption rate Curve of figure 9 tells us about the influence of coarse sand on the water absorption rate.

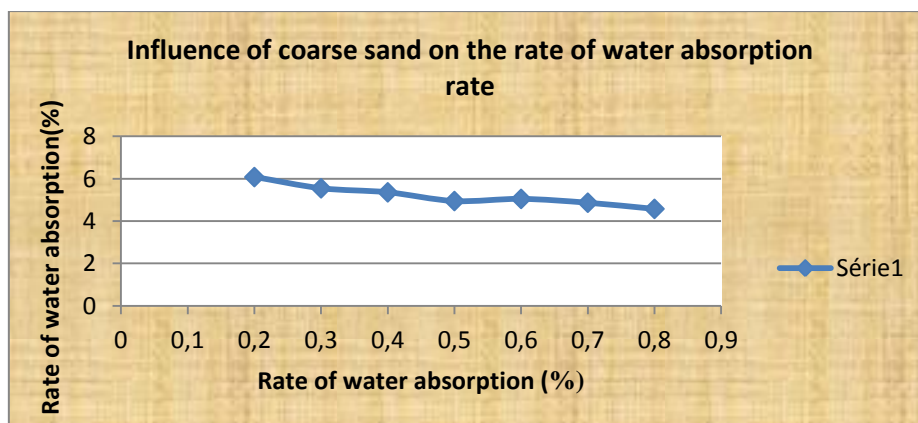

Figure 9: Influence of coarse sand on the rate of water absorption rate

Analysis and discussion: The change in the absorption rate of the specimens according to the coarse sand rate is plotted on the Figure 6. It can be said that the curve appears to lead to an assessment of the intrinsic rate of absorption. Such behavior of the samples is similar to that of micro concrete tiles [BAGAN G. C., 2002].

The study of the absorption of water by the samples shows that the water absorption capacity for different types of samples is inversely proportional to the rate of coarse sand contained in the latter.

4. Conclusion

Studies conducted as part of this work whose objective is the promotion of local building materials in Benin to improve their performance in terms of mechanical characteristics, focused on the case materials bilayers tiles coated granites. The materials of the study: coarse sand, cement, terrazzo was first analyzed individually and characterized before use. Overall, after preparation of specimens, testing and studies have focused on the mechanical characterization of bilayer and the influence of coarse sand rate on the said characteristics. Standardized tests on sand and evaluation of mechanical characteristics of specimens (three-point bending strength and compression strength) by the three-point bending tests and compression are between the other methods. We can remember that:

- coated terrazzo tiles are suitable for both internal and external coatings on our premises
- 20% of coarse sand rates, bilayers provide good three-point flexural strength and compression; and a normal water absorption rate. They therefore can in these circumstances be used for coating. The area subject of this study is particularly interesting that this vast and real possibilities of research. Indeed, our studies have focused on a number of tests; we should continue research while studying other properties. Damage to the coatings has the main origin of the aging process, and degradation due to moisture.

It would be interesting to study aging and hydrothermal behavior of bilayers. Furthermore, the field of building materials is at the crossroads of comfort and security of the economy. It would therefore be very useful for further study in the direction of environmental security, and especially of the economy (compared to conventional materials).

Acknowledgments

Our sincere thanks to POTEMAT for Financial support through the Project "Promotion of local materials"

References

- BAILON J-P & DORLOT J-M.** – *Des matériaux*- Presses internationales polytechniques, Ecole nationale polytechnique – Montréal, 2000.
- BARON J.** – *Fissuration du béton par hydratation localement différée du ciment*- L.C.P.C ? Mai 1971, Rapport de recherche n°15.
- BARON J.** – La résistance à la propagation de fissure- **In** : *le béton hydraulique* - Paris : Presses de l'Ecole Nationale des ponts et chaussées, 1982- p.317-333.
- BRAZIER J.F.** – *Caractérisation de la tolérance à l'endommagement et de la durabilité des composites ciment-verre par des essais de flexion avec des cycles de chargement- déchargement* – Thèse de doctorat de l'université Claude Bernard de Lyon 1, 1991.
- Moslemi, A.A.** (1999). Emerging Technologies in Mineral-Bonded Wood and Fiber Composites. *Advanced Performance Materials* 6: 161-179.
- Jiang, S.P., Mutin, J.C., Nonat, A.** (1995). Studies on mechanism and physico-chemical parameters at the origin of the cement setting. I. The fundamental processes involved during the cement setting. *Cement and Concrete Research* 25: 779-789.
- Stutzman, P.** (2004). Scanning electron microscopy imaging of hydraulic cement microstructure. *Cement & Concrete Composites* 26: 957-966.
- Taylor, H. F. W.** (1997). *Cement chemistry*. 2nd ed. Thomas Telford.
- TOUKOUROU Chakirou A.** 2010 .Cours de Physiques des matériaux.
- BAGAN G. C.** – Contribution à l'amélioration des tuiles en micro béton-caractérisation des matériaux et des structures, 2002-p .44